



Westinghouse

USER'S MANUAL

MANUEL DE L'UTILISATEUR

MANUAL DEL USUARIO

VR-3225

1	IMPORTANT INFORMATION		2
2	HOW TO INSTALL THE STAND		4
3	PREFACE		5
4	SAFETY PRECAUTIONS		5
5	CONTENTS		7
6	FRONT/BACK CONNECTIONS OF LCD TV		8
7	TV INSTALLATION	Power Cord Connection	9
		Antenna Connection	9
		AV Connection	10
		YPbPr(component) Connection	10
		VGA(PC) Connection	11
		Service Port Function	11
		HDMI Connection	12
8	REMOTE CONTROL	Remote control instructions in TV mode	13
		Remote control setup	14
9	MENU OPERATION	SETUP WIZARD	15
		Operating the Menu	17
		PICTURE Menu	18
		AUDIO Menu	19
		TIME Menu	19
		SETUP Menu	20
		LOCK Menu	22
CHANNEL Menu	24		
10	TROUBLESHOOTING		26

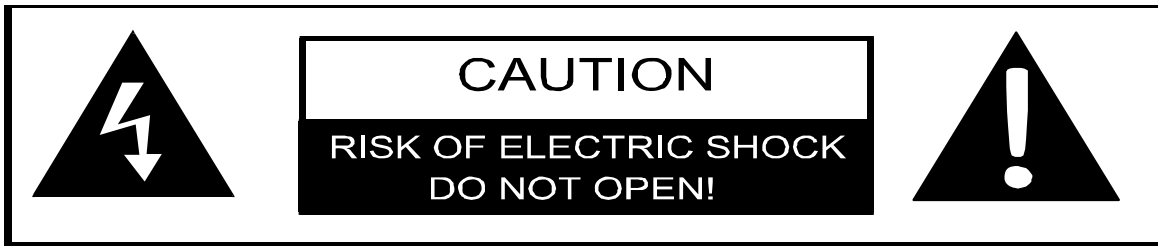

The lightning flash with arrowhead symbol, within an equilateral triangle, is intended to alert the user to the presence of un-insulated dangerous voltage within the products enclosure that may be of sufficient magnitude to constitute a risk of electric to persons.



The exclamation point within an equilateral triangle is intended to alert the user to the presence of important operating and maintenance (servicing) instruction the literature accompanying the appliance.

CAUTION: USE OF ANY CONTROLS, ADJUSTMENTS, OR PROCEDURES OTHER THAN THOSE SPECIFIED HEREIN MAY RESULT IN HAZARDOUS RADIATION EXPOSURE.

CAUTION: These servicing instructions are for use by qualified service personnel only. To reduce the risk of electric shock, do not perform any servicing other than that contained in the operating instructions unless you are qualified to do so.

Refer to service manual for servicing instructions.

Important Safety Instructions

Note:

1. Read these instructions.
2. Keep these instructions.
3. Heed all warnings.
4. Follow all instructions.
5. Do not use near water.
6. Clean only with dry cloth.
7. Do not block any ventilation openings. Install in accordance with the manufacturer's instructions.
8. Do not install near any heat sources such as radiators, heat registers, stoves, or other apparatus (including amplifiers) that produce heat.
9. Do not defeat the safety purpose of the polarized or grounding-type plug. A polarized plug has two blades with one wider than the other. A grounding type plug has two blades and a third grounding prong. The wide blade or the third prong are provided for your safety. If the provided plug does not fit into your outlet, consult an electrician for replacement of the obsolete outlet.

10. Protect the power cord from being walked on or pinched particularly at plugs, convenience receptacles, and the point where they exit from the apparatus.
11. Only use attachments / accessories specified by the manufacturer.
12. Use only with the cart, stand, tripod, bracket, or table specified by the manufacturer, or sold with the apparatus.
When a cart is used, use caution when moving the cart / apparatus combination to avoid injury from tip-over.



13. Unplug this apparatus during lightning storms or when unused for long periods of time.
14. Refer all servicing to qualified service personnel. Servicing is required when the apparatus has been damaged in any way, such as power-supply cord or plug is damaged, liquid has been spilled or objects have fallen into the apparatus, the apparatus has been exposed to rain or moisture, does not operate normally, or has been dropped.
15. Apparatus shall not be exposed to dripping or splashing and that no objects filled with liquids, such as vases, shall be placed on the apparatus.
16. **WARNING:** To reduce the risk of fire or electric shock, do not expose this apparatus to rain or moisture.
17. Mains plug or appliance coupler is used as the disconnect device, shall be readily operable.
18. The apparatus shall be connected to a MAINS socket outlet with a protective earthing connection.

How to install the stand

English

1

Fix the base cover to the fixed-ring base as image 1.

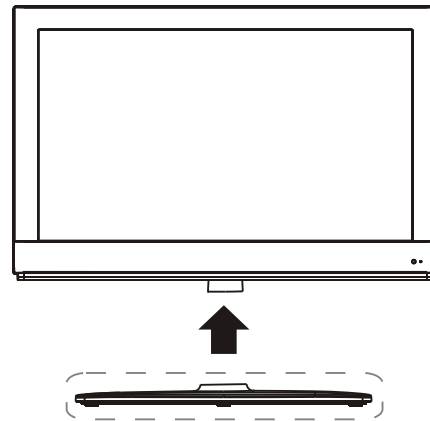

2

Assembly two small parts in image2 at the bottom of the Base Cover and fix with 6 screws in the Screw Hole.

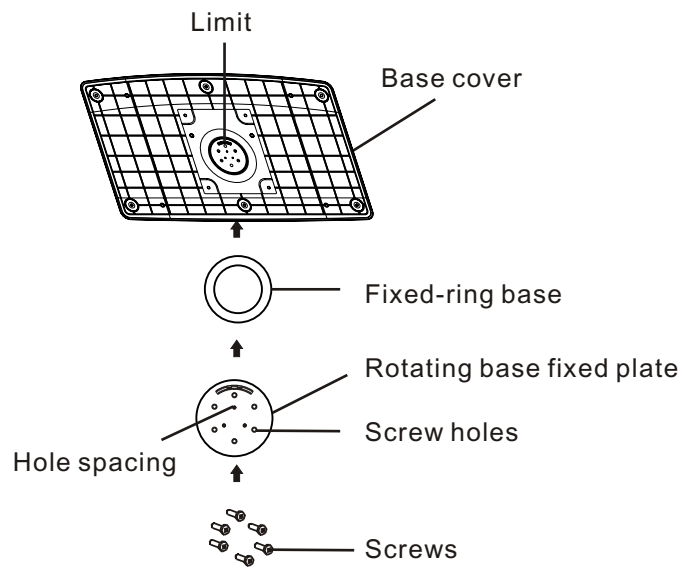

3

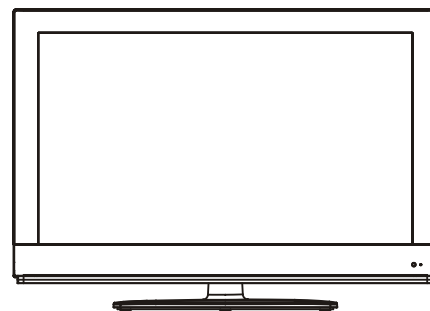

3. PREFACE

Thank you for buying this TV! Please read this manual thoroughly before operating the TV. Make sure the TV was not damaged in transit. Should the TV be damaged, do not install it and contact your dealer. Check that you have all the accessories according to the model.

4. SAFETY PRECAUTIONS



Put the TV on a stable surface.



Do not place any material on the TV.

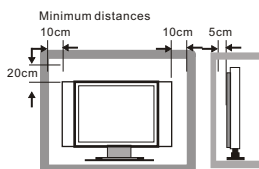

Do not use the TV with fixtures other than those provided or suggested by the manufacturer.

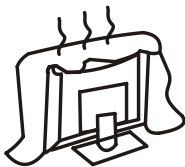

Do not block or cover the ventilation openings on the TV. If you have a wall mount, check that it is steady.



Power cord and cables must be properly routed and protected to prevent people from stepping on them and causing the TV to fall.

SAFETY PRECAUTIONS

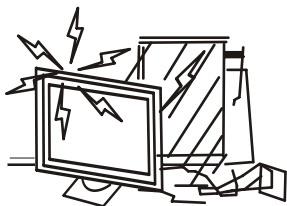

Keep the TV dry and away from humidity.

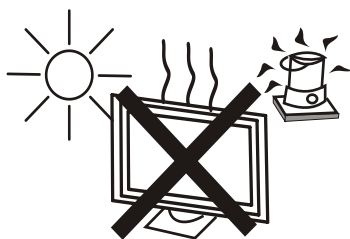

Keep the TV away from heat sources.



Unplug the TV before cleaning it. Do not use solvent or liquid to clean the TV.

Only clean the TV with a soft and dry cloth.

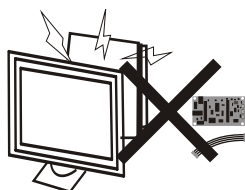

In case of troubleshooting, do not use spare parts other than those suggested by the manufacturer. Using inadequate spare parts can lead to electric shocks, short-circuits, fire or other incidents.



Unplug the TV during lightning storms or when unused for long periods of time.

5. CONTENTS



LCD TV SET



Remote Control

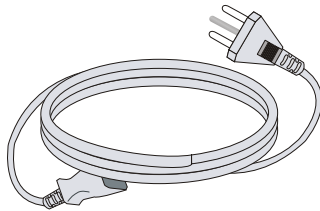

Power Cable

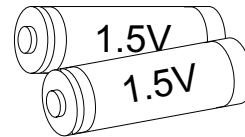

AAA Batteries

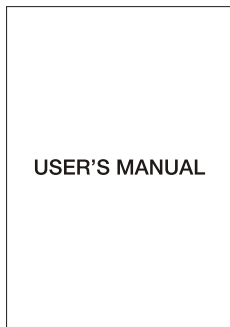

USER'S MANUAL

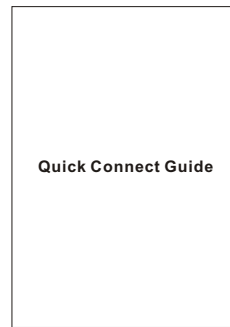

Quick Connect Guide

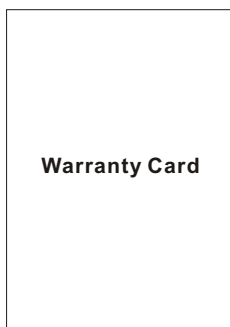

Warranty Card

6. FRONT/BACK CONNECTIONS OF LCD TV

Front View



1. Press “POWER” button to turn the TV on or off.
2. Press “SOURCE” to select the input source.
3. Press “MENU” to bring up the main menu on the screen.
4. Press “CH+” or “CH-” to scan through channels.
5. Press “VOL+” or “VOL-” to increase or decrease the volume.
6. POWER INDICATOR: Shows red in standby mode. Shows red or green when your TV is switched on.
7. REMOTE SENSOR: infrared sensor for the remote control.

Back View and Control Connections

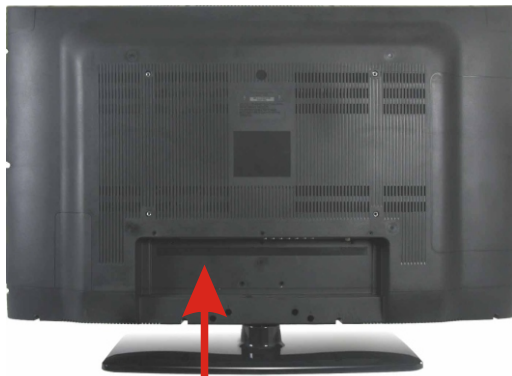

- 1.AC IN: Main power input.
- 2.USB Service: USB port for Factory Use Only.
- 3.HDMI1 / HDMI2: Connect to the HDMI output jack of a DVD player.
- 4.VGA (PC): Connect to the VGA RGB output jack of a PC.
- 5.PC AUDIO: Connect to the Audio output jack of a PC.
- 6.COMPONENT: Connect to the YPbPr output jack of a DVD or VCR player.
7. AV: Connect to the Video output jack of a DVD or VCR player.
- 8.AUDIO IN: Connect to the Audio output jack of a DVD or VCR player.
- 9.RF IN: Connect to an antenna or cable source.
- 10.HEADPHONE: Connect to a headphone.

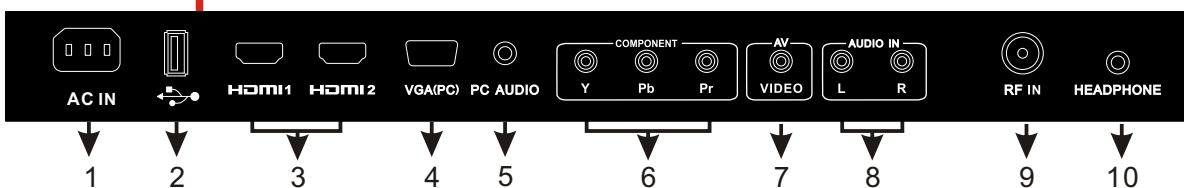

7. TV INSTALLATION

Power Cord Connection

- Connect the power cord correctly as shown.
- Press the POWER switch of your LCD TV to switch on the LCD TV. The power indicator on the front panel lights up in red or green.

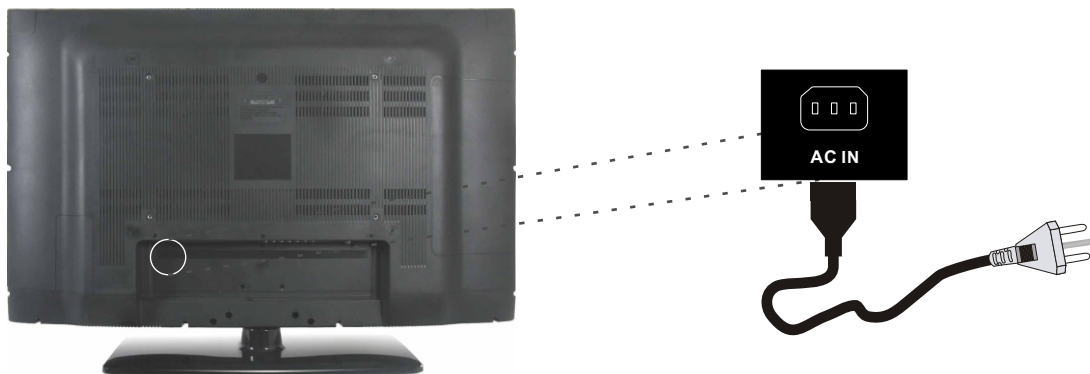

Antenna Connection

To ensure good picture and sound, TV antenna system needs to be installed. The antenna system as shown can be sourced from TV equipment shops, which will provide service for correct installation and connection. After installation, insert the 75-ohm antenna plug into the antenna jack as shown.

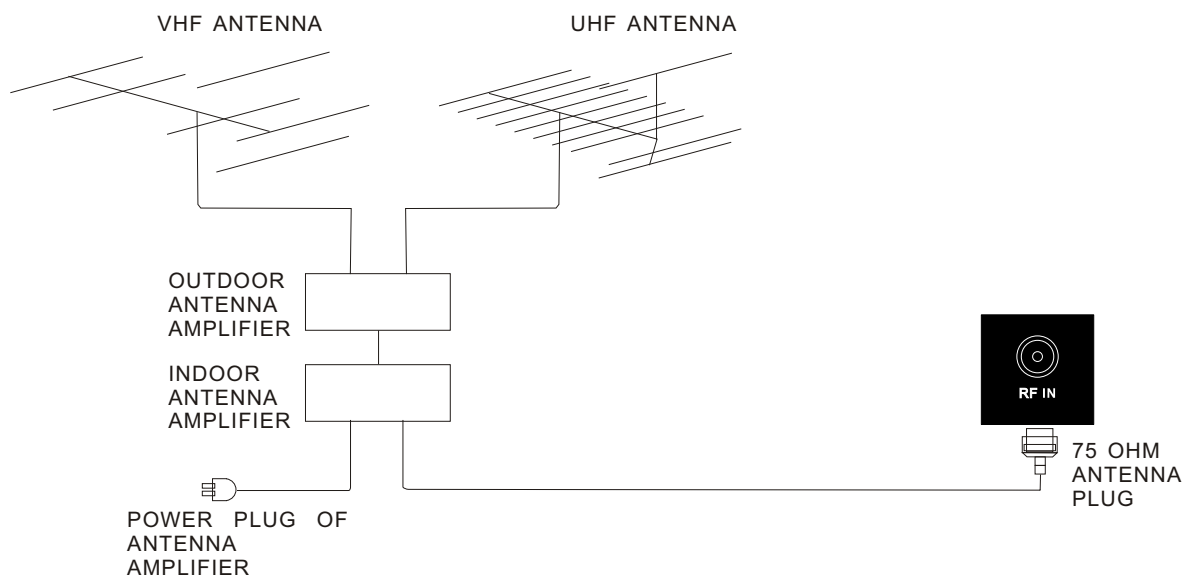

AV Connection

Connect the VIDEO and AUDIO output jack of the DVD or VCR to the VIDEO jacks on the set using the RCA cable. Match the jack colors: Video is yellow, Audio left is white, and Audio right is red. Select the AV input source using the SOURCE button on the remote control.

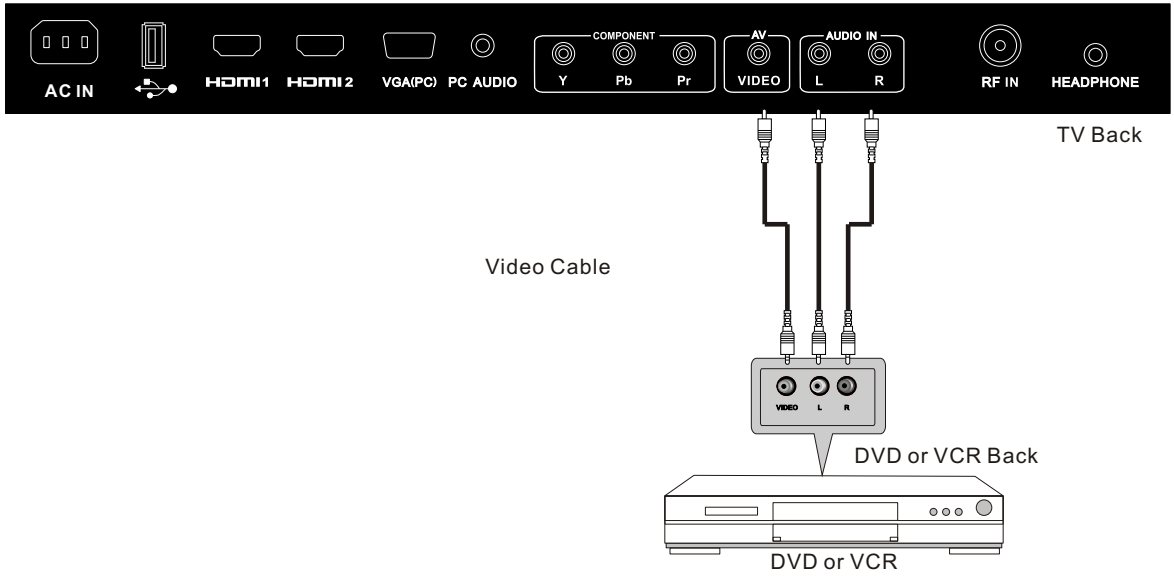

YPbPr(Component) Connection

Connect the YPbPr output of the DVD or VCR to the YPbPr input on the set. The picture quality is improved; compared to connecting a regular VCR to the video input. Connect the Audio output of the DVD or VCR to the Audio input jacks on the set using the RCA cable. Match the jacks colors :Y is green,Pb is blue,Pr is red,Audio left is white and Audio right in red. Select component input source using the SOURCE button on the remote control.

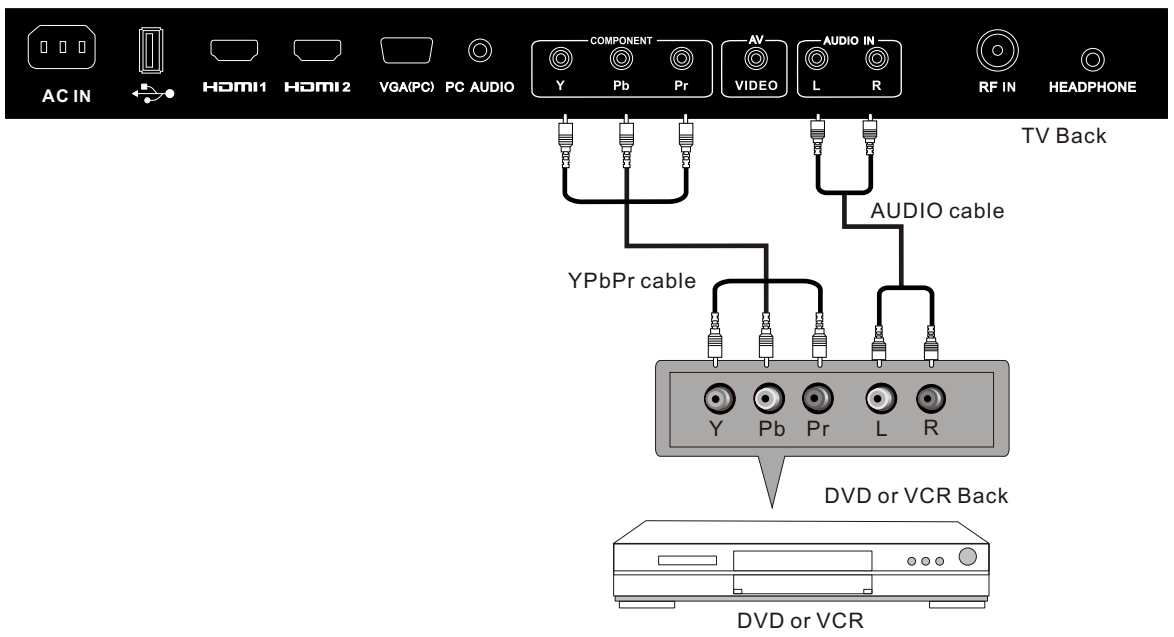

VGA(PC) Connection

Connect the RGB output of the PC to the VGA(PC) jack on the set. Connect the AUDIO output of The PC to the PC AUDIO jack on the set. Select the RGB input source with using SOURCE button on the remote control.

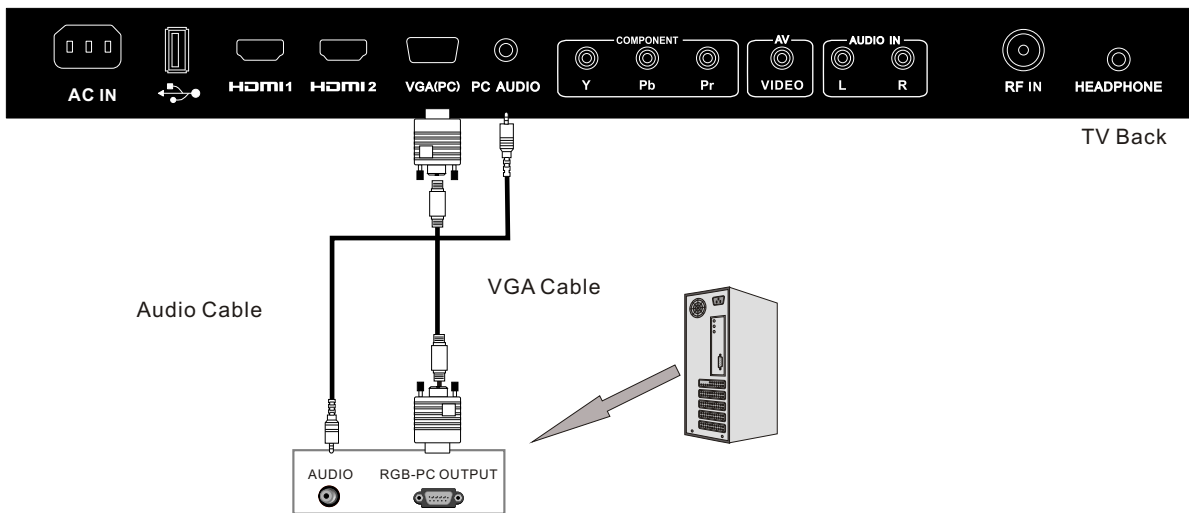

Service Port Function

Service port: (For factory uses only.)

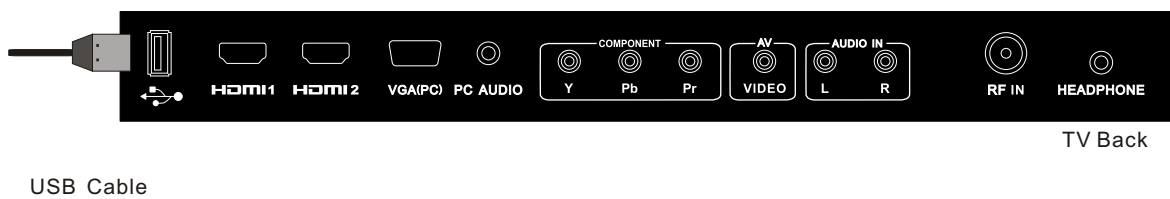

HDMI Connection

HDMI plug which replaces the HDMI connection allows transfer of all audio/video/control signals through one cable only. These signals are transferred in digital.

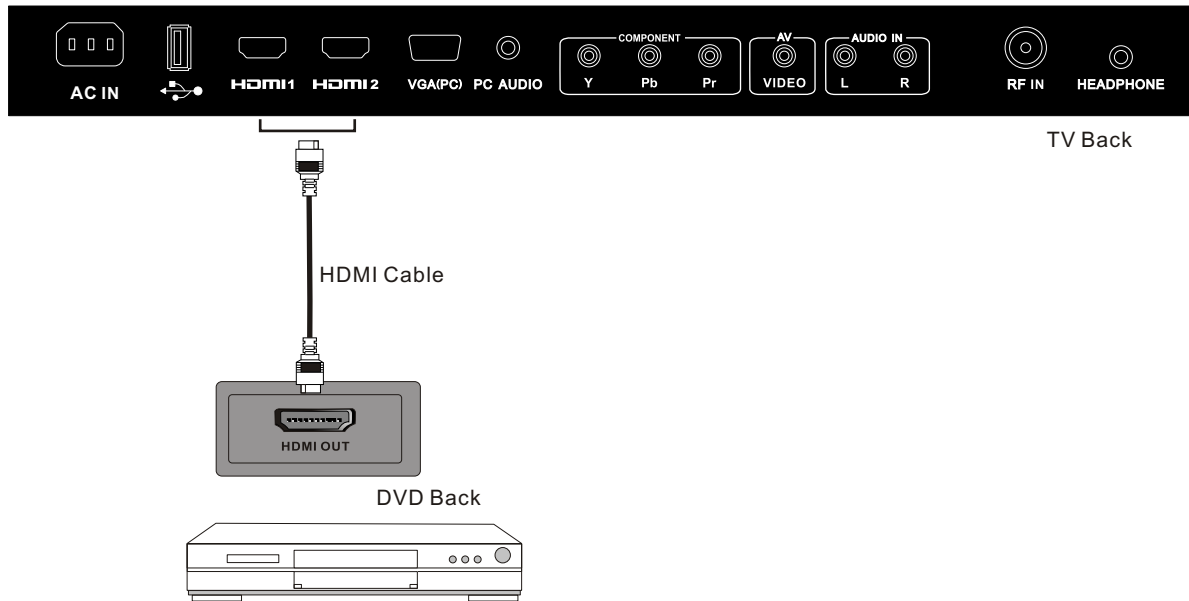

8. REMOTE CONTROL

Remote control instructions in TV mode

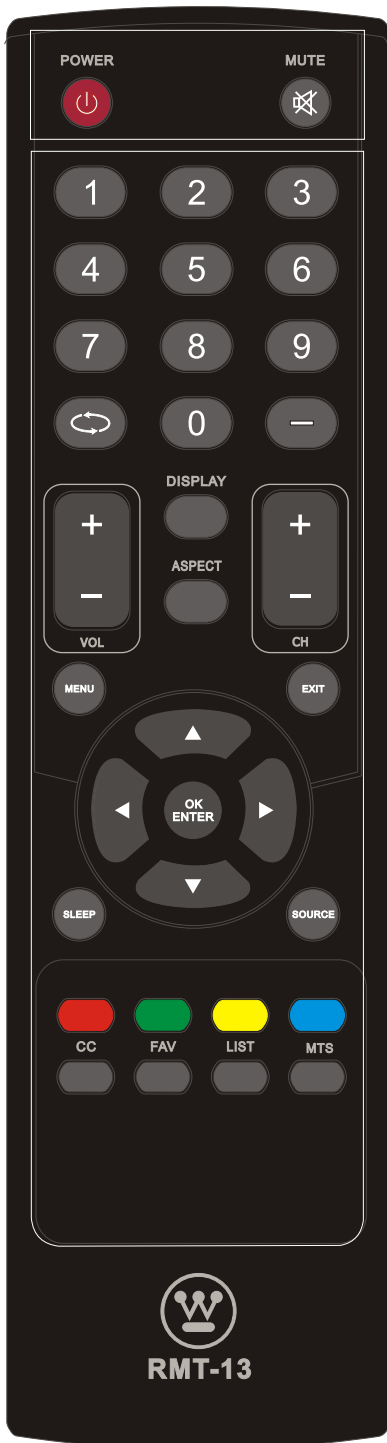

POWER

Turn the LCD TV ON or OFF.

MUTE

Press to mute the sound. Press again or press VOL+ to un-mute the TV.

NUMBER BUTTONS

Press 0-9 to directly change the TV channel.

SOURCE

Press SOURCE to display the OSD input source, press ▲ ▼ to select an input source, and then press OK to confirm.

-

Press this button to enter a program number for multiple program channel such as 2-1, etc.



Return to the previous channel viewed.

DISPLAY

Press to display the source and channel's information.

MENU

Brings up the main TV menu to the screen.

EXIT

Exit the main TV menu to the screen.

ASPECT

Press to select Aspect Ratio.

THUMBSTICK(▲ / ▼ / ◀ / ▶ / OK)

Allows you to navigate the on-screen menus and adjust the system settings to your preference.

VOL+/VOL-

Press to increase / decrease the sound level.

CH+/CH-

Press to scan through channels.

CC

Press to display the closed caption.

LIST

Press to display the TV program list.

FAV

Press to display the TV favourite program list.

MTS

Press to adjust between available audio channel.

Remote control setup

1. Open the cover.
2. Uses AAA size batteries. When inserting the batteries, make sure correct polarities “+” and “-” marks on the batteries line up correctly with compartment markings.
3. Replace the battery cover.

To prevent battery leakage which may result in bodily injury or damage to the remote:

1. Install all batteries correctly, and as marked on the remote control.
2. Do not mix batteries: (OLD and NEW or CARBON and ALKALINE, etc)
Remove batteries when the remote is not used for a long period of time.

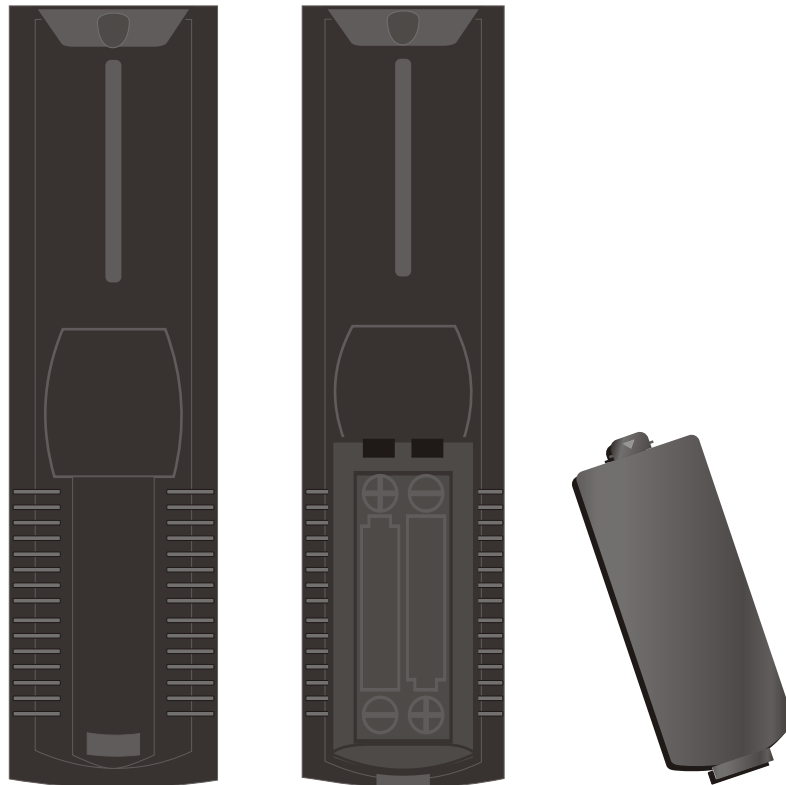

9.Menu Operation

SETUP WIZARD

Select Language

Select Language

Welcome to the Westinghouse TV Setup Wizard.

Follow this guide to help setup your HDTV for scanning channels or accessing your external devices for cable, satellite, Blu-ray, DVD, and gaming.

Use the Up and Down arrows on your remote control to select the language to use for menus and message screens.

English

Français

Español

⏏:Select Enter:Next

English

Time zone

Time Zone

Use the Up and Down arrows on your remote control to select your local time zone.

Hawai(UTC-10)

Alaska(UTC-9)

Pacific(UTC-8)

Mountain(UTC-7)

Central(UTC-6)

Eastern(UTC-5)

Go Back

⏏:Select Enter:Next

Power On Mode

Use the up and down arrows on your remote control to select power on mode.

Home

Retail

Go Back

⏏:Select Enter:Next

Setup Wizard

Cable or Satellite Source Input

Use the left/right arrows on your remote control to select the type of connection you are using to connect the set top box?

For optimal video quality, we recommend HDMI or Component (refer to Quick Connect Guide or User Manual to help you determine what connection you are using).

HDMI Component Other Antenna

Go Back

⏏:Select Enter:Next

Let's Get Connected...

Click here to connect a Cable Box or Satellite Box.

Click here to connect a Game, Blu-Ray, DVD, or other player.

Click here to scan channels from the Antenna or coaxial cable

Go Back

⏏:Select Enter:Next

Source menu

TV

AV

Component

HDMI1

HDMI2

VGA

Scan Channels from the Antenna or coaxial cable input

Use the Up and Down arrows on your remote control to select the channel scan type.

Antenna[ATSC]

Cable

Go Back

⏏:Select Enter:Next

Channel Scan

Scan Channels from the Antenna or coaxial cable input

Use the Up and Down arrows on your remote control to select the channel scan type.

Antenna[ATSC]
Cable

Go Back

⊙⊙⊙⊙ :Select Enter:Next

Antenna[ATSC] →

Antenna [ATSC] Channel Access

Antenna users need a Channel Access Code in order to perform a channel scan and receive broadcast signals. Contact Westinghouse's Channel Access Service by:
Web: www.westinghousedigital.com/support; select Channel Access and enter Access Info
Text Message: Text Tuner to 95495
Phone: 1-800-701-0680 follow instructions.
Select Next to obtain the Access code.

Go Back Next

⊙⊙⊙⊙ :Select Enter:Next



Antenna [ATSC] Channel Access Information

To access channel scan you will need the following Access Information:
Model: xxxxxxxx
Serial No: xxxxxxxx
Channel Scan Type: ATSC

Provide these items to Westinghouse's Channel Access Service by web, text, or phone to obtain an Access Code, then select Next to input access code.

Go Back Next

⊙⊙⊙⊙ :Select Enter:Next



Enter Channel Access Code

Using your remote control to enter the 5 digit access code provided by the channel access service.

Go Back Next

0-9: Key in password Enter:Next



Scanning Channels

RF CH: 7
Found: 4

Menu:Quit

Cable ↓

Cable or Satellite Source Input

Use the left/right arrows on your remote control to select the type of connection are you using to connect the set top box?
For optimal video quality, we recommend HDMI or Component (refer to Quick Connect Guide or User Manual to help you determine what connection you are using).

HDMI Component Other Antenna

Go Back

⊙⊙⊙⊙ :Select Enter:Next

Antenna ↓

Antenna RF Warning

Notice: Westinghouse Digital does not recommend using the RF Antenna input as your cable or satellite connection because it will provide poor video quality to your HDTV. Use a different connection for optimum conditions. If you do not have a cable box that provides an HD quality signal, we recommend that you call your cable provider for an upgrade. Otherwise, select Proceed.

Exit Setup Proceed

Go Back

⊙⊙⊙⊙ :Select Enter:Next

Proceed ↓

Scanning Channels

RF CH: 7
Found: 4

Menu:Quit

Scanning Channels

RF CH: 7
Found: 4

Menu:Quit

If the password is wrong.

ERROR: Access Code Incorrect

Check the access code provide by the Channel Access Service, then select Go Back to enter the access code again.
If the Channel Access continues to fail contact Westinghouse Digital customer service at 1-800-701-0680 for further assistance.

Go Back

⊙⊙⊙⊙ :Select Enter:Next

Operating the Menu

1. Press the POWER button to turn the LCD TV on.
2. Press the MENU button on the remote control, the on-screen menu will appear on the screen.
3. Use the LEFT and RIGHT buttons to select your main menu option.

PICTURE MENU:

Allows you to make adjustments to your picture settings.(select TV source for example)

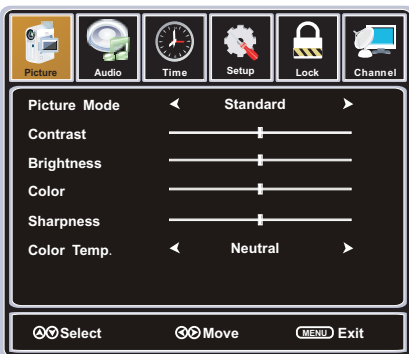

AUDIO MENU:

Allows you to customize the audio options and effects.(select TV source for example)

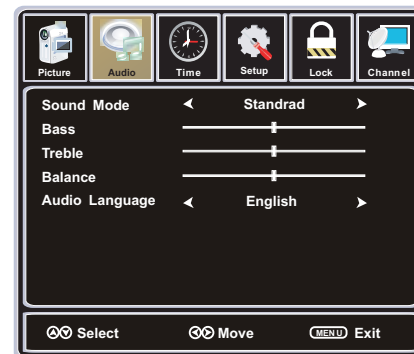

TIME MENU:

Allows you to set up a variety of timer options. (Select TV source for example)

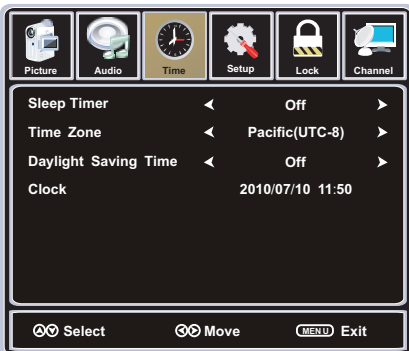

SETUP MENU:

Allows you to set up a variety of setup options. (Select TV source for example)

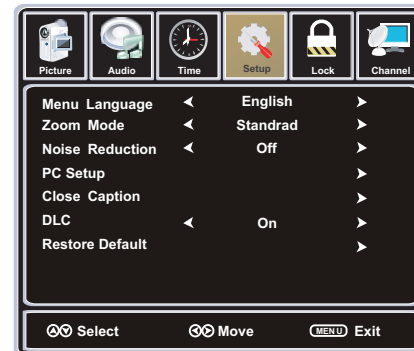

LOCK MENU:

Allows you to set up a variety of lock options. (Select TV source for example)

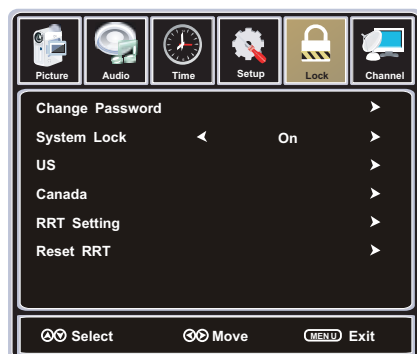

CHANNEL MENU:

Allows you to search channels and set up a variety of channel options. (Select TV source for example)

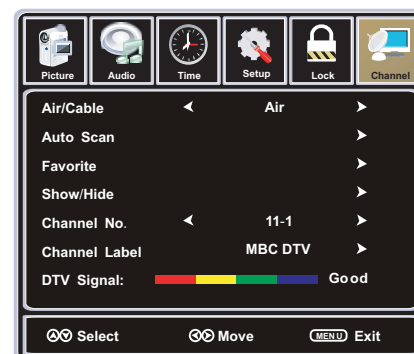

MENU OPERATION

4. Use the UP/DOWN buttons to select an option of the sub-menu, and press the RIGHT button.
- While in adjustment mode, use the LEFT/RIGHT button to change the value of the item.
5. Press the MENU button to exit the menu.

Note:

Only when you input the suitable signal, the relevant items can be activated.

1. Press the POWER button to turn the LCD TV on.
2. Press the MENU button on the remote control, the on-screen menu will appear on the screen.
3. Use the LEFT and RIGHT buttons to select your main menu option.

PICTURE Menu

Select TV source for example.

1. Press the MENU button on the remote control to display the Main menu, and use the LEFT and RIGHT buttons to select the PICTURE.
2. Use the UP and DOWN buttons to highlight an individual PICTURE option, use the LEFT and RIGHT buttons to change the setting, and press the MENU to exit the menu.



The PICTURE menu includes the following options :

Picture Mode

Cycles among picture display modes: Standard, Dynamic, Mild, User.

Contrast

Controls the difference between the brightest and darkest regions of the picture.

Brightness

Controls the overall brightness of the picture

Color

Control the color.

Sharpness

Increase this setting to see crisp edges in the picture; decrease it for soft edges .

Color Temp.

Cycles among color temp: Neutral, Warm, Cool.

AUDIO Menu

Select TV source for example.

1. Press the MENU button on the remote control to display the Main menu, and use the LEFT and RIGHT buttons to select the AUDIO.
2. Use the UP and DOWN buttons to highlight an individual AUDIO option, use the LEFT and RIGHT buttons to change the setting, and press the MENU to exit the menu.

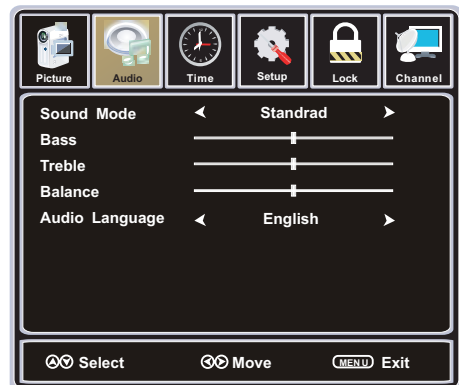

The AUDIO menu includes the following options :

Sound Mode

Allows you to select among: Standard, Music, Movie, User.

Bass

Controls the relative intensity of lower pitched sounds.

Treble

Controls the relative intensity of higher pitched sounds

Balance

To adjust the balance of the left and right sound track, or turn off the volume of the left and right sound track.

Audio Language

Allows you to select audio languages among: English, Français, español.

TIME Menu

Select TV source for example.

1. Press the MENU button on the remote control to display the Main menu, and use the UP and DOWN buttons to select the TIME.
2. Use the UP and DOWN buttons to highlight an individual TIME option, use the LEFT and RIGHT buttons to change the setting, and press the MENU button to exit.



MENU OPERATION

The TIMER menu includes the following options :

Sleep Timer

Allows you to set up the sleep timer among: 5min, 10min, 15min, 30min, 45min, 60min, 90min, 120min, 180min, 240min and off.

Time Zone

Allows you to set up the sleep timer among: Pacific(UTC-8), Alaska(UTC-9), Hawaii(UTC-10), Eastern(UTC-5), Central(UTC-6) and Mountain(UTC-7).

Daylight Saving Time

Allows you to turn on or off the daylight saving time.

Clock

Display the current time.

SETUP Menu

Select TV source for example.

1. Press the MENU button on the remote control to display the Main menu, and use the LEFT or RIGHT button to select the SETUP.
2. Use the UP and DOWN buttons to highlight an individual SETUP option, use the LEFT and RIGHT buttons to change the setting, and press the MENU button to exit.

The SETUP menu includes the following options:

Menu Language

Allows you to select menu language among: English, Français and Español.

Zoom Mode

Allows you to select the zoom mode among: Standard, Fill, Overscan.

Noise Reduction

Allows you to select the noise reduction mode among: Strong, Off, Weak, Middle.

PC Setup (In VGA Mode only)

Input PC signal first, then press SOURCE button to select VGA mode, press RIGHT button to confirm.

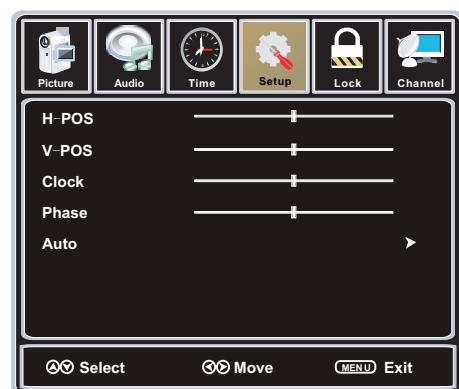
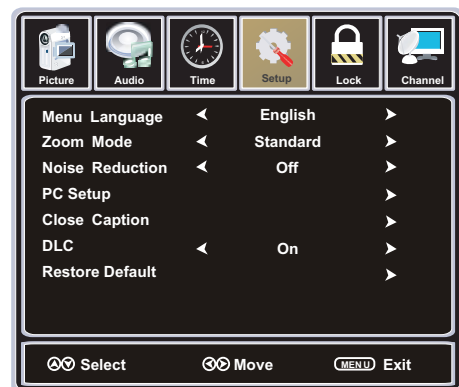

- H-Position** Allow you to use LEFT and RIGHT button to adjust the H Position.
- V-Position** Allow you to use LEFT and RIGHT button to adjust the V Position.
- Clock** Allow you to prolong the image.
- Phase** Allow you to adjust the definition.
- Auto** Select "Auto" and press RIGHT, the unit will automatically adjust all items to achieve a best effect.

Close Caption

Use Down button to highlight the Close Caption item, then press RIGHT button to enter into the following menu.

CC Mode

Allows you to select the CC Mode among: On, Off and CC on Mute.

Basic Selection

Allows you to select the basic selection among: CC1, CC2, CC3, CC4, Text1, Text2, Text3 and Text4.

Advanced Selection

Allows you to select the advanced selection among: Service1, Service2, Service3, Service4, Service 5 and, Service 6.

Option

Use Down button to highlight the “Option” item, then press RIGHT button to enter into the following menu.

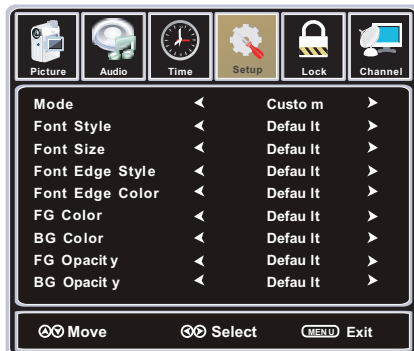

Use UP and DOWN buttons to highlight the desired item, and use LEFT and RIGHT buttons to select.

DLC

Dynamic luminance control ON or OFF .

Restore Default

Restores all settings to factory settings.



LOCK Menu

Select TV source for example.

1. Press the MENU button on the remote control to display the Main menu, and use the LEFT and RIGHT buttons to select the LOCK
2. Use the DOWN button to highlight the "Enter Password" item, use the numeric keys to input 4-digital password, then the screen will display the junior menu. After settings, press menu button to exit.

NOTE: The factory password is 0000.

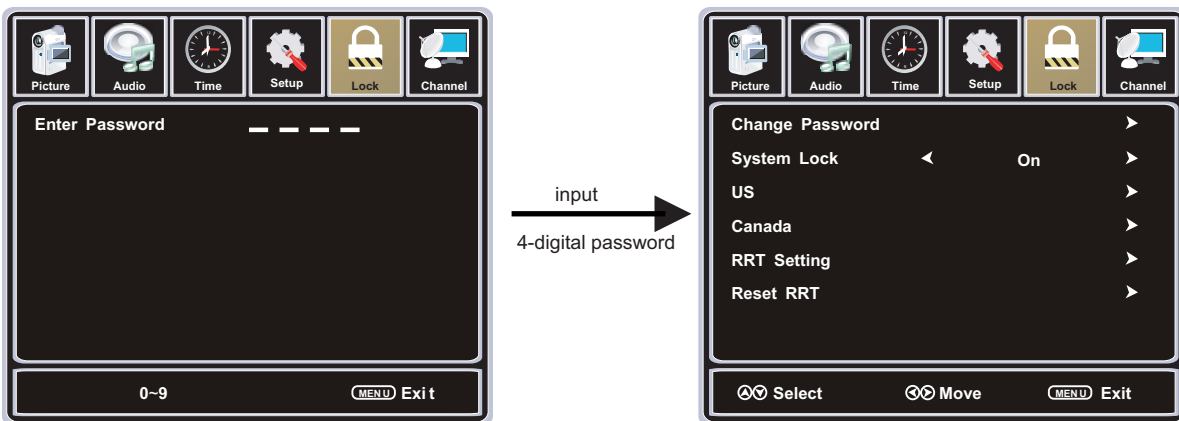

The LOCK menu includes the following options :

Change Password

Use DOWN button to select the "Change Password" item, then press RIGHT button to enter into the following menu. Input the new 4-digital password and input it again to confirm.

System Lock

Allows you to turn on or off the system lock. If you turn off the system lock, then the following items (US, Canada, RRT Setting and Reset RRT) will unable to use.

US

Use Down button to highlight the "US" item, then press RIGHT button to enter into the following menu.

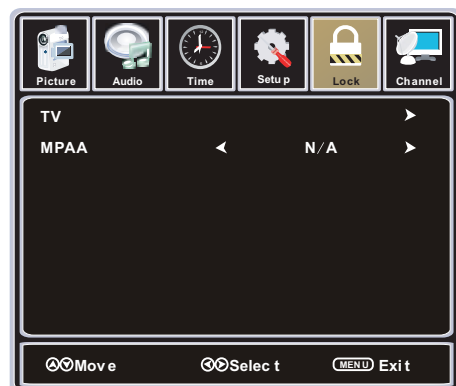

TV

Use Down button to highlight the “TV” item, then press RIGHT button to enter into the following menu.

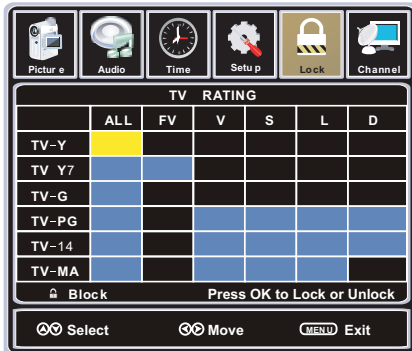

Use UP and DOWN buttons to select the desired rating and press RIGHT button to block or unblock rating.

MPAA

The Movie rating (MPAA) is used for original movies rated by the Motion Picture Association of America (MPAA) as broadcasted on cable TV and not edited for television.

Use UP or DOWN button to select N/A, G, PG, PG-13, R, NC-17 or X.

RATING	DESCRIPTION
G	General Audiences. Movie is appropriate for all ages.
PG	Parental Guidance Suggested. May contain material not suited for younger viewers.
PG-13	Contains content that may not be appropriate for viewers under the age of 13.
R	Restricted. Contains adult content, no one under 17 admitted without parent.
NC-17	No one 17 and under admitted.
X	Adults only.

Canada

Use Down button to highlight the “Canada” item, then press RIGHT button to enter into the following menu.

Canada Eng

Use LEFT and RIGHT buttons to select among: E, C, C8+, G, PG, 14+ and 18+

Canada Fre

Use LEFT and RIGHT buttons to select among: E, G, 8ans+, 13ans+, 16ans+ and 18ans+



RRT Setting

Rating Region Table setting.

Reset RRT

Allows you to reset the RRT setting.

CHANNEL Menu

Select TV source.

1. Press the MENU button on the remote control to display the Main menu, and use the LEFT and RIGHT buttons to select the CHANNEL.
2. Use the UP and DOWN buttons to highlight an individual CHANNEL option, use the LEFT and RIGHT buttons to change the setting, and press the MENU button to exit.

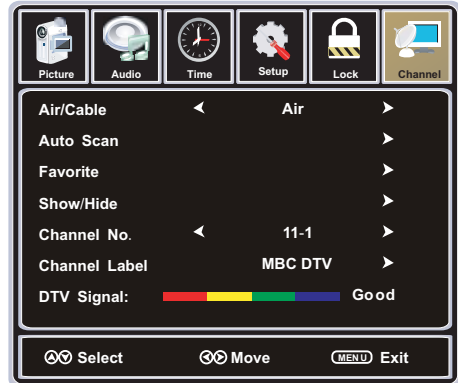

The CHANNEL menu includes the following options :

Air/Cable

Allows you to select antenna between Air, QAM and Cable.

Use Down button to highlight the “Auto Scan” item, then press RIGHT button to enter into the following menu.

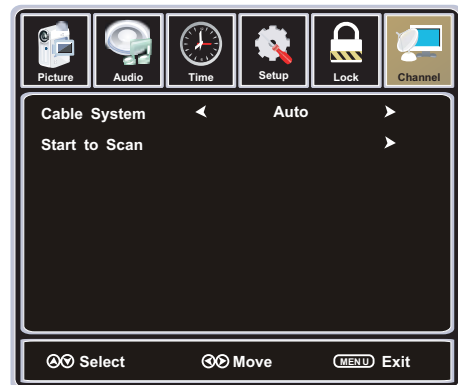

If you select “Air” as input signal in Antenna item, you can press RIGHT button to search the channels automatically.

The receivable channels will be stored automatically. When searching channels, press MENU to stop.



If you select “Cable” as input signal in Antenna item, allows you to select Cable System among: Auto, STD, IRC and HRC. Use DOWN button to highlight the “Start to Scan”, then press RIGHT button to search the channels automatically. The receivable channels will be stored automatically. When searching channels, press MENU to stop.

Favorite

Allows you to add these channels which you desired as the favorite channels.

Use UP or DOWN button to highlight the “Favorite”item, then press RIGHT button to enter into the following menu.

Use UP and DOWN button to highlight the desired item, then press OK button to add or remove the highlighted channel as favorite.



Show / Hide

Allows you to show or hide the channels.

Use UP or DOWN button to highlight the “Show / Hide” item, then press RIGHT button to enter into the following menu.

Use UP and DOWN button to highlight the desired item, then press OK button to show or hide the highlighted channel.



Channel No.

Display the number of current channel.

Channel Label

Display the lable of current channel.

TV Signal

Display the quality of current TV signal.

10. Troubleshooting

Please check if you can solve problems by troubleshooting yourself.

Troubleshooting	Control
No signal	Please check that all cables are correctly plugged in.
No color shades	Adjust the contrast, the color and the brightness.
Stain on the screen	May be the result from a lighting signal from car, motor, neon light and other electrical devices or appliances.
Double or multiple display image	May be the result of an electrical wave disturb from other TV, Computer and Game machine or Radio.
Snow on the screen	The cables of the antenna are not correctly plugged in.
The remote control does not work	Please check the batteries order and alignment. Check that the IR of the remote control is not hidden by something.
"Zip" made noise on TV cover	Even if the display image is correct, the noise may come from an unsteady fixation of the panel.
No sound	Make sure that you have not press the MUTE button of the panel or of the remote control.



www.westinghousedigital.com



S/N: _____



Westinghouse Digital, LLC
Orange, CA

SE-UM-3205-0101